

Technical Bulletin 036 – Zero 36₂0 FM 1.6-2.3m³ & 2.3-4.03m³ Installation Guide

Rev2 16/05/2017

The Lifeline Zero 36₂0 FM extinguisher range (UK Patent No. GB2523902; UK Patent Application No. GB 1516832.1) is homologated to FIA8865-2015 standard. These systems provide a high level of protection for you and your vehicle and have been extensively tested by Lifeline, the FIA, and BSI to meet the FIA 8865-2015 requirements. The information below provides a guide to installing your chosen system. Unfortunately, due to the variety of vehicles being raced the exact location of the components of the systems cannot be fully defined by Lifeline; this document provides “best practise” advice suitable for the vast majority of vehicles. If you feel that your installation cannot follow these guidelines, please contact Lifeline Technical for further guidance.

Fully read and understand the instructions below before starting installation. Plan your installation carefully referring to the tables below and the system drawings. Do not cut the supplied tubing, over-braid or the plug and lead sets until you are certain of the location of the cylinder, connectors, nozzles, switches and power pack.

Other References	
TB001	System Care, maintenance and Service
TB003	Novec MSDS
TB005	AFFF MSDS
TB036	Zero 36 ₂ 0FM – Kit Content and Spares

Section 1 – Cylinder, Bracket and Straps

Item	Fixing Type and No.	Location and Fitting Guide
Cylinder and Bracket -	4xM6 nut, bolt and washers. Vibration washers and/or Nylocs are highly recommended. The use of self-tapping screws or inserts is not permitted	Mount transversally in the car and within the safety cell/roll cage. For recommended location, refer to Section 6. Homologation label and FIA Hologram must be visible for scrutineering. Avoid positions where cylinder is likely to be damaged or be exposed to excessive heat.

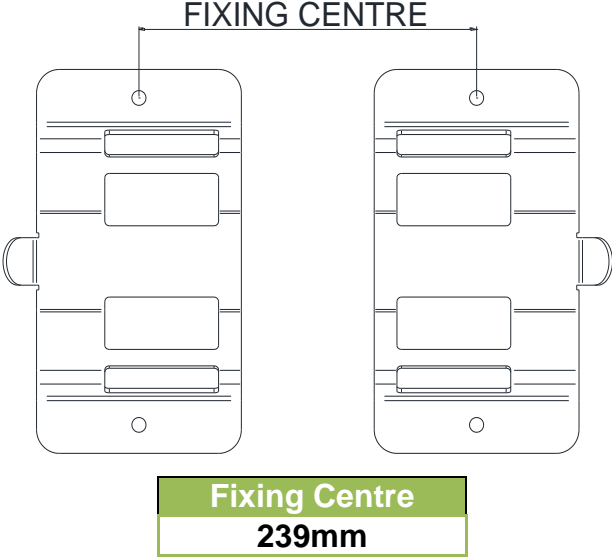
Item	Fixing Type and No.	Location and Fitting Guide
 <p style="text-align: center;">Figure 1 – Bracket Fixing Centres</p>		
Straps	2No. T-Bolt straps/cylinder	Thread through provided slots in brackets and around the cylinder. Tighten T-bolts using spanner.

Section 2 – Delivery Network – Tube and Connectors

Item and System Type	Fixing Type and No.	Location and Fitting Guide						
8mm & 10mm Tube & Over-braid – Cockpit and Engine Bay	Cable ties or P’clips as required	<p>Referring to section 3 and 6, cut tube to pre-measured length using a dedicated tube cutter, ensuring that there are no sharp edges and that the tube remains circular. Do not use a hack saw or similar tool; this will leave a jagged edge which will make fitting of nuts and olives difficult.</p> <p>Form the tube using a pipe bender taking care not to create a kink which could restrict flow (hand bending is possible but not preferred). Minimum bend radius of the tube is shown below</p> <table border="1" data-bbox="679 1771 1382 1881"> <thead> <tr> <th>Tube Ø</th> <th>Minimum Bend Radius</th> </tr> </thead> <tbody> <tr> <td>8mm</td> <td>30mm when using pipe bending tool</td> </tr> <tr> <td>10mm</td> <td>30mm when using pipe bending tool</td> </tr> </tbody> </table>	Tube Ø	Minimum Bend Radius	8mm	30mm when using pipe bending tool	10mm	30mm when using pipe bending tool
Tube Ø	Minimum Bend Radius							
8mm	30mm when using pipe bending tool							
10mm	30mm when using pipe bending tool							

Item and System Type	Fixing Type and No.	Location and Fitting Guide
		Measure and cut over-braid to fit over the cut and formed tube, securing the ends of the over-braid with heat shrink to prevent fraying. Secure the Tube using cable ties and saddles or P'clips.
Connectors	N/A	<p>Drill an Ø18mm hole to fit the bulkhead connector. Fit nuts and olives to all tubing and start pushing the tube into the connectors. Tighten until the olive has securely gripped the tube and removal is no longer possible. A second spanner check is recommended once all connections have been made.</p> <p><i>Lifeline recommend torque marking the connectors to provide a simple visual check that they remain secured</i></p>

Section 3 – Nozzles

The Cockpit Nozzles discharge a heavier than air suppressant forming a gaseous blanket which rapidly extinguishes a fire. The Engine – Novec 1230 Nozzle flood fills the compartment with a gaseous suppressant for fast “knock-down” of fire and the Engine – Twin Fan nozzles keep the fire from reigniting due to hot engine components. Consideration should be given to location of the wide angle Twin Fan foam nozzles for best coverage of the engine from both sides. 2 auxiliary foam nozzles are supplied which can be fitted to target specific areas, such as a turbo or manifold, if required; positioning of these nozzles is free.

Nozzle Type	Fixing Type and No.	Location
Cockpit Nozzles	Fabricated bracket to suit	<p>The nozzles must be located as shown in Section 6; several options are possible and it is important to assess risk and choose the best for your car. The nozzles must not be obstructed in any way and must have clear line of sight. Obstruction could reduce the effectiveness of the extinguisher.</p> <p>Nozzles must be mounted taking note of the requirement for roll cage padding as detailed in FIA Appendix J Art 253 & 283</p>

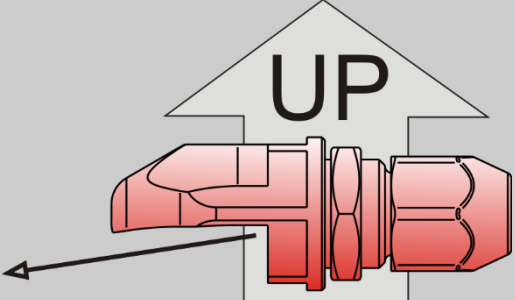
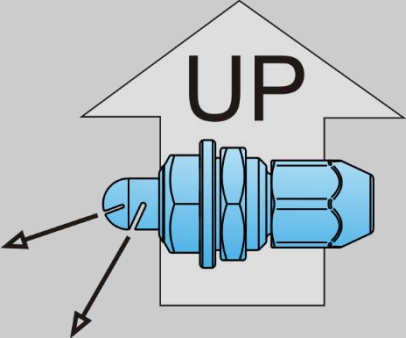
Nozzle Type	Fixing Type and No.	Location
		 <p data-bbox="858 840 1310 869">Figure 2 – Cockpit Nozzle Correct Orientation</p> <p data-bbox="679 904 1299 972">DO NOT AIM THE NOZZLE DIRECTLY AT OCCUPANTS</p>
Engine – Novec 1230 Nozzle	Bulkhead mount or fabricated bracket	Locate the engine Novec 1230 nozzle as high as possible at the rear of the engine bay, it should have clear sight of the engine and be as close to the centre line of the car as possible.
Engine – Twin Fan Nozzles	Fabricated bracket to suit	Locate the Twin Fan Nozzles either side of the engine, either front and back of the engine bay for a transverse engine or either side for a longitudinal engine. The axis of the nozzles should be horizontal and the slots aimed at the engine  <p data-bbox="804 1686 1361 1715">Figure 3 – Engine – Twin Fan Nozzle Correct Orientation</p>
Engine – Auxiliary Nozzles	Fabricated bracket to suit	<i>The Engine – Auxiliary Nozzles are an optional fit but are strongly recommended to target specific hot areas likely to cause re-ignition</i>

Nozzle Type	Fixing Type and No.	Location
		Location of the nozzles is free, they should be aimed at likely re-ignition areas such as a turbo, injector rail, manifold, etc.

Section 4 – Activation

Item	Fixing Type and No.	Location
Power Pack	4No. M4 Countersunk screw and nuts	<p>The power pack must be located where it can be reached and operated by the driver/co-pilot. In the majority of cars this will be on the centre of the dash or centre console area.</p> <p>The switch is a lift gate type and must be operated by pulling the switch outwards and over the lift gate. Failure to do so could result in damage.</p> <p>Ensure that the LED indicator lights are visible to the driver and that cables are routed so that they cannot be accidentally damaged.</p>
Activation Switches	Ø13.6mm hole and supplied lock nut	<p>Locate one switch in the cockpit where it can be reached and activated by the driver & co-pilot when seated with harnesses on.</p> <p>Locate the second switch externally directly next to the electrical cut-off switch</p>
Plug and Leads	Cable ties as required	<p>Plug and lead sets have colour coded heat shrink at the plug end to identify which connection on the extinguisher they go to.</p> <p>Locate each plug and lead as required between Power Pack, Activation Switches and Extinguisher. Solder joints, sealing with glue lined heat shrink to protect from water ingress. Pay attention to the joints at switches and cover the pins with glue lined heat shrink to prevent moisture ingress and prevent accidental short circuits.</p> <p>All wiring must be covered in the supplied over-braid, securing over the end connectors at the extinguisher and power pack using cable ties or heat shrink. This protects the cable from heat damage, abrasion and accidental removal.</p> <p>Refer to system schematic in Section 6.</p>



Item	Fixing Type and No.	Location
Remote Activation	Cable ties as required	<p>If using the remote activation function, you will have the ability to activate the extinguisher system via the cars telemetry links from the pits. Follow the instruction above for Plug and Leads noting that this function has polarity, refer to system schematic in Section 6.</p> <p>This requires a 5-20V input for 0.3sec</p>

Section 5 – System Checking

Item	Procedure
Power Pack	<p>CARE: The switch is a lift gate type and must be operated by pulling the switch outwards and over the lift gate. Failure to do so could result in damage.</p> <ol style="list-style-type: none"> Fit the supplied PP3 battery to the power pack (<i>Lifeline recommend removing the battery from the power pack in between events</i>) Connect all plug and leads once they have been fully assembled following the instruction in Section 4. and diagram in Section 6. Ensure the two position toggle switch on the power pack is in the TEST position Press one of the two activation switches. The power pack then performs automatic checks of the battery condition and wiring loom If the system is correctly wired and the battery condition is good, the AMBER LED will illuminate for ~5 seconds and then go out. (<i>Remote activation option can also be checked by pressing the activation button in the pits and having the driver confirm that the TEST LED illuminates and goes out as above</i>) If the AMBER LED flashes, there is a problem. Error codes are: - <ol style="list-style-type: none"> 2 flashes = Battery problem – replace battery 3 flashes = Circuit problem – check BLUE plug and lead sets and activation switches 4 flashes = Circuit problem – check GREEN plug and lead set and activation switches Once the system has confirmed that it is working correctly (no error codes), move the switch to the ARMED position. The RED LED will now flash every 3 seconds The system continuously monitors the battery and circuit, if an error is found the RED LED will cease to flash
Extinguisher	<ol style="list-style-type: none"> Check that the cylinder is in date and has been serviced every two years as required Check the weight of the extinguisher against that shown on the serial label. Lifeline use regularly calibrated highly accurate scales and it can

Item	Procedure
	be expected that some variance will be found from the weight as shown when using other equipment 3. Check the pressure gauges are in the green area of the scale. Some fluctuation can be observed in high and low temperatures, this is normal.

Section 6 – System Illustrations

Figure 4 – Engine Nozzle Locations

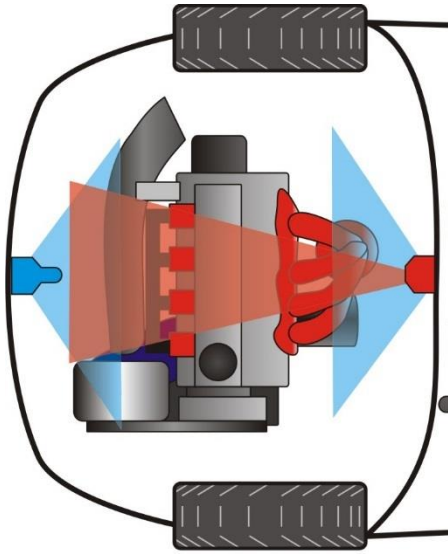

Transverse Engine

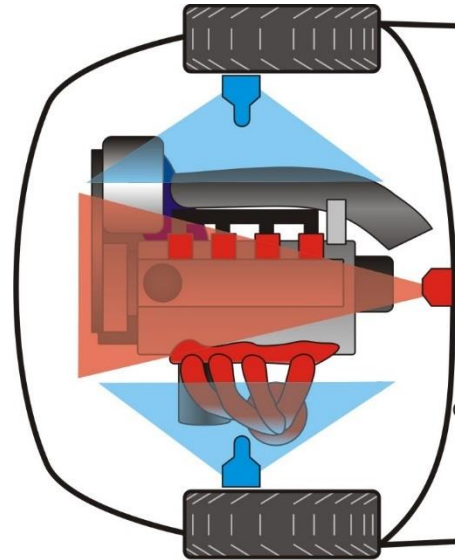

Longitudinal Engine

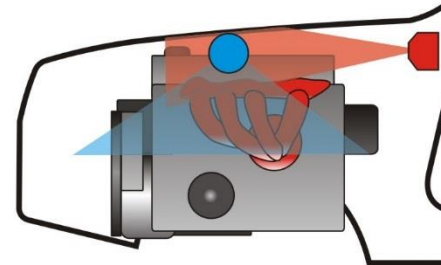
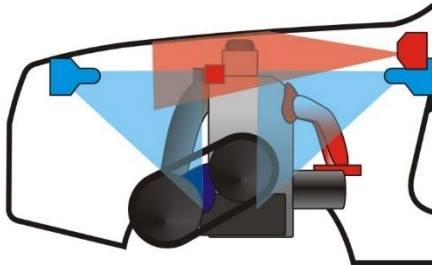
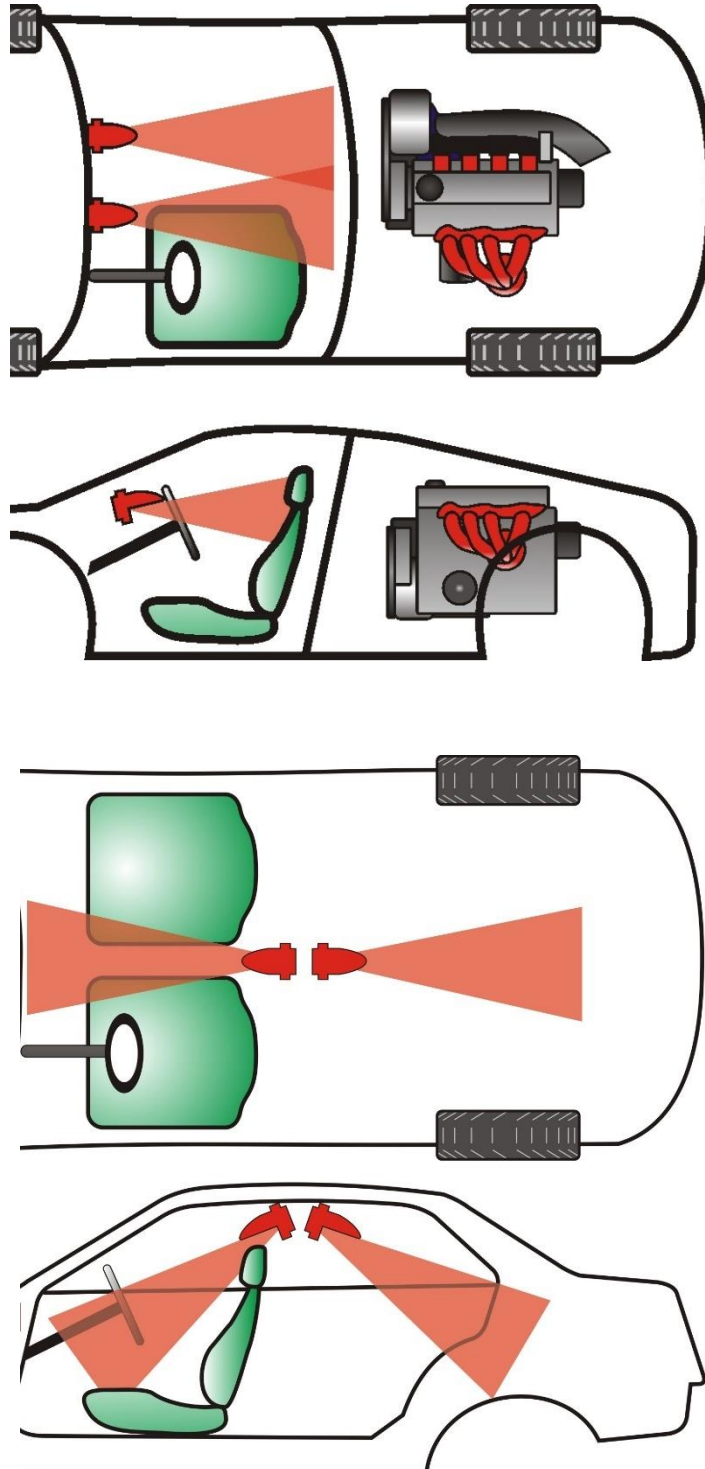

Figure 5 - Cockpit Nozzle Location/Orientation



Front Mount

Suitable for mid/rear engine GT & closed cockpit sports cars only. Nozzles MUST be above dashboard level
(If the roll cage is used it must be a section of roll cage that does not require padding IAW

Centre Mount 1

Suitable for saloon & front engine GT cars
(If the roll cage is used it must be a section of roll cage that does not require padding IAW Appendix J art 253 & 283)

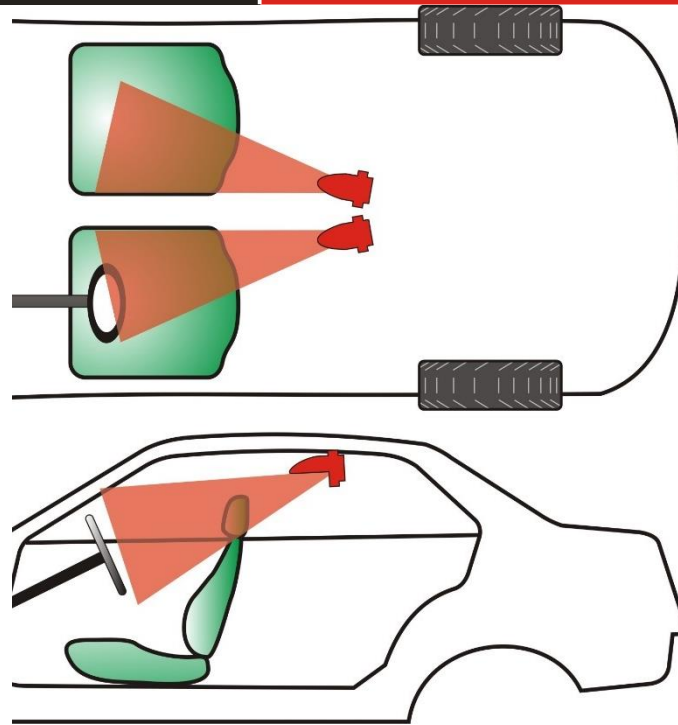

Centre Mount 2

Suitable for saloon, mid/rear engine GT & closed cockpit sports cars

(If the roll cage is used it must be a section of roll cage that does not require padding IAW Appendix J art 253 & 283)

Figure 6 – Extinguisher Location

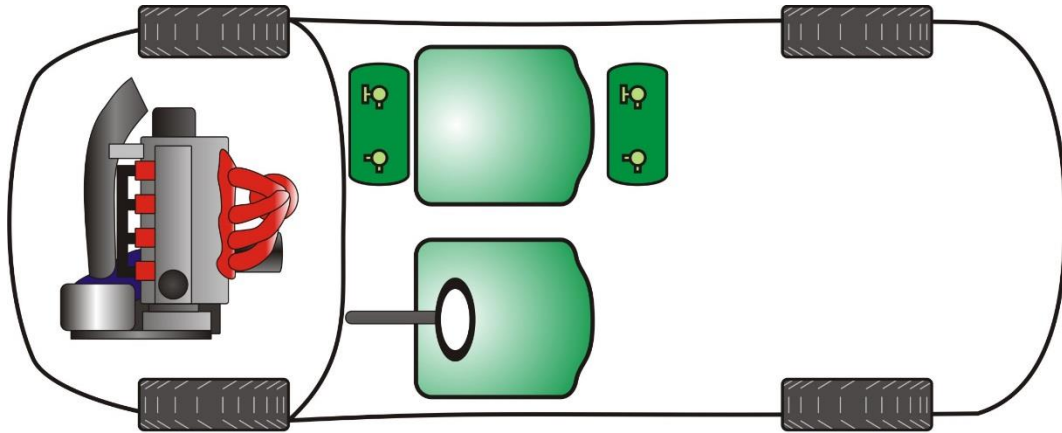

Cylinder Location is free within the cockpit volume but should ideally be mounted transversely and must be away from strong heat sources

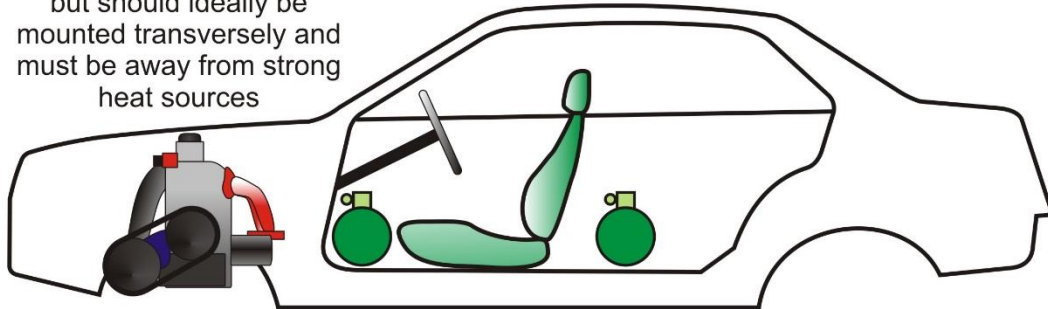
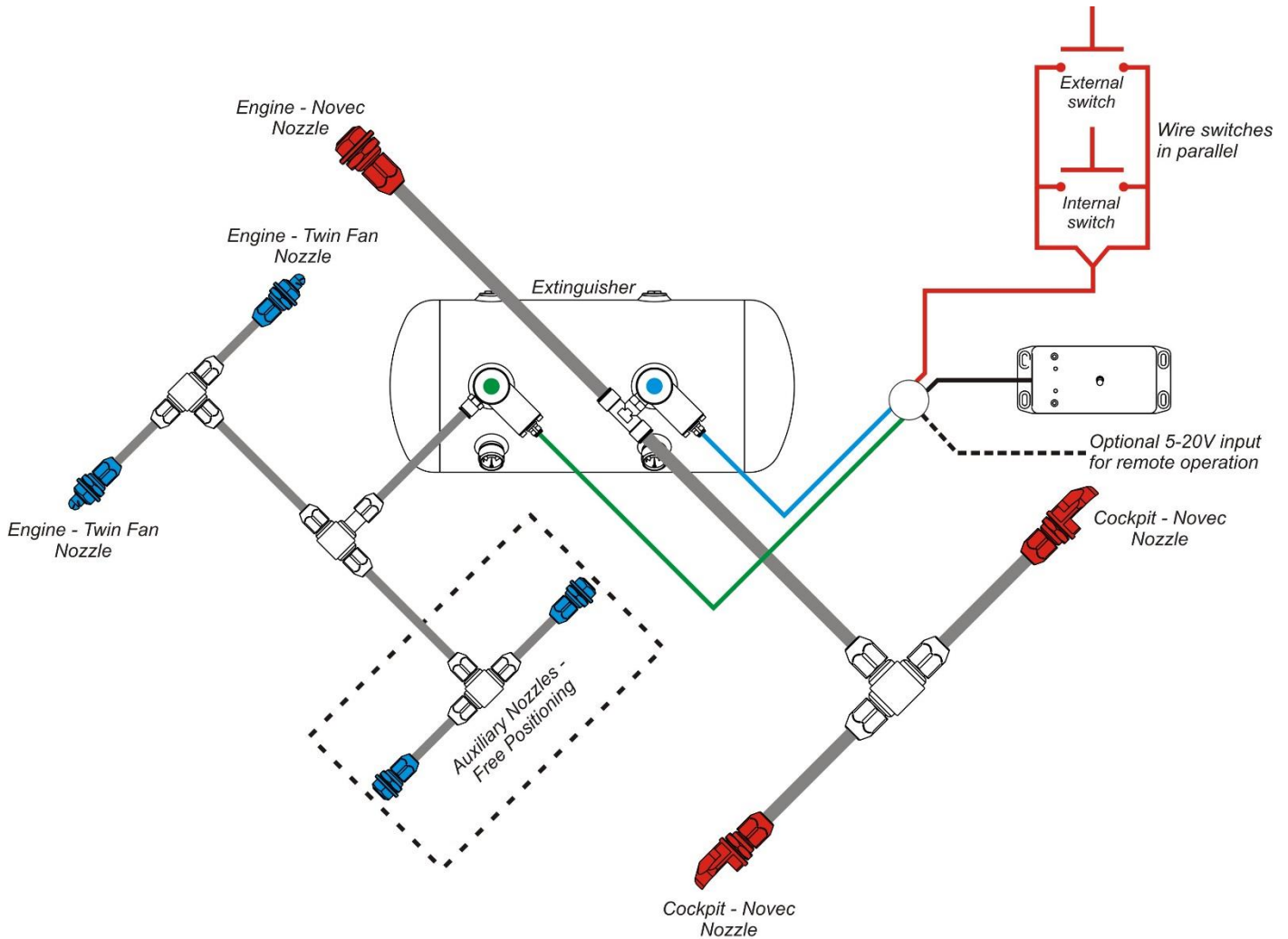

Figure 7 – System Schematic



WIRING COLOURS

- 1 - **WHITE** = SWITCH
- 2 - **BROWN** = SWITCH
- 3 - **GREEN** = BLUE PLUG AND LEAD
- 4 - **YELLOW** = BLUE PLUG AND LEAD
- 5 - **GREY** = GREEN PLUG AND LEAD
- 6 - **PINK** = GREEN PLUG AND LEAD
- (Blue and Green plug and leads have no polarity)
- 7 - **BLUE** = -VE REMOTE ACTIVATION
- 8 - **RED** = +VE REMOTE ACTIVATION



System Part Number	
System Serial Numbers	
Date of Manufacture	
Service 1 Date	
Service 2 Date	
Service 3 Date	
Service 4 Date	
Service 5 Date	
Notes	

Notes

1. INSTALLATION DU SYSTEME D'EXTINCTION / FIRE EXTINGUISHER SYSTEM INSTALLATION

101. INSTALLATION DANS L'HABITACLE / COCKPIT INSTALLATION

- a) Emplacement et orientation du corps

Location and orientation of body

- b) Emplacement et orientation des buses

Location and orientation of nozzles

- c) Précaution à prendre lors de l'installation du système

Special care to take with the installation of the system

Transversally, and within the safety cell/roll cage

Aimed as shown in E1-2 below

Nozzle must not be obstructed in any way. Do not aim the nozzle at occupants of the car. Ensure cylinder is not positioned where it could be damaged or exposed to extreme heat See Lifeline Technical Bulletin 016 for detailed installation instructions

E1-1) Installation dans l'habitacle (emplacement et orientation du corps)

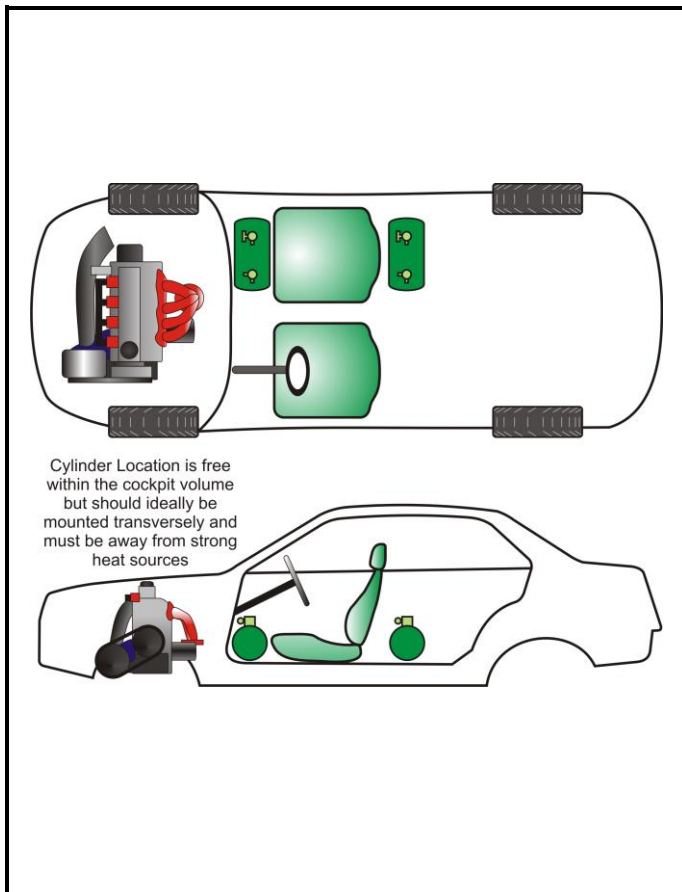

E1-2) Installation dans l'habitacle (emplacement et orientation des buses)

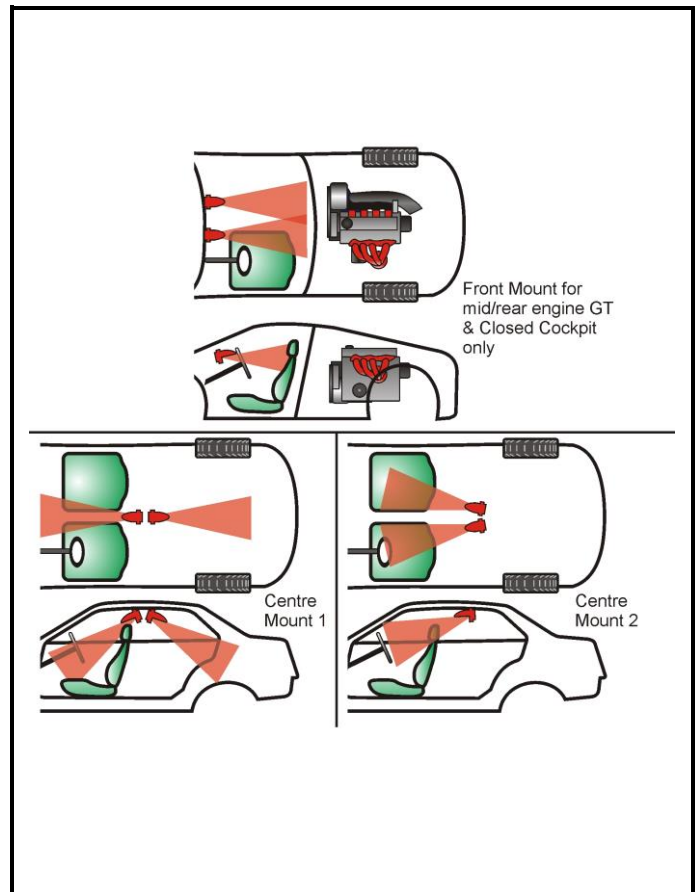

102. INSTALLATION DANS LE MOTEUR / ENGINE INSTALLATION

a) Emplacement et orientation du corps

Location and orientation of body

Transversally, and within the safety cell/roll cage

b) Emplacement et orientation des buses

Location and orientation of nozzles

Aimed as shown in E2-2 below

c) Précaution à prendre lors de l'installation du système

Special care to take with the installation of the system

Nozzles must not be obstructed in any way. See Lifeline Technical Bulletin 016 for detailed installation instructions

E2-1) Installation dans le moteur (emplacement et orientation du corps)

Engine installation (location and orientation of body)

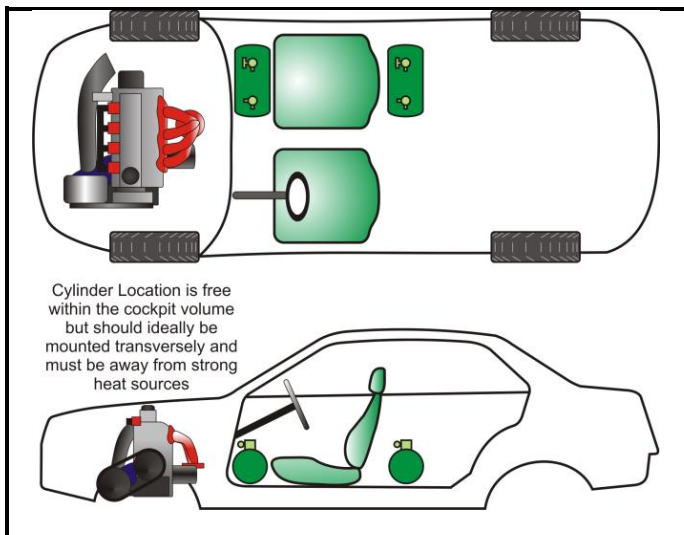

E2-2) Installation dans le moteur (emplacement et orientation des buses)

Engine installation (location and orientation of nozzles)

